

In assessing biological UV-B effects, natural fluctuations of solar radiation should be taken into account

Regas Santas¹, A. Koussoulaki¹ & D.-P. Häder²

¹OikoTechnics Institute, Kefallenias 50, 16342 A. Helioupolis, Greece; ²Friedrich-Alexander Universität, 91058 Erlangen, Germany

Key words: Outdoor UV-B, UV-A, PAR measurements, Spectral balance

Abstract

Daily and weekly fluctuations of PAR, UV-A, and UV-B have been continuously monitored for 5 months in Ancient Korinthos, Greece (37°58' N, 23°0' E) using a calibrated instrument based on 3 sharp band sensors. Daily dose ranged between 521–12 006 kJ m⁻² for PAR; 52–1, 239 kJ m⁻² for UV-A; and 0.66–22.5 kJ m⁻² for UV-B. Weekly dose ranged between 16 778–81 788 kJ m⁻² for PAR; 1 406–8 517 kJ m⁻² for UV-A; and 18–151 kJ m⁻² for UV-B. UV-B/PAR and UV-A/PAR ratio distribution, however, does not follow closely PAR fluctuations. Generally, the UV-B/PAR and UV-A/PAR ratios were high in bright light conditions (2.1×10^{-3} , 118×10^{-3}) and low in darker weeks (0.9×10^{-3} , 63×10^{-3}). The UV-B/UV-A ratio exhibits smaller fluctuations with season (20×10^{-3} , 12×10^{-3}). Attention is drawn to the effects of sudden changes in ambient radiation and to the ratios of UV-B, UV-A, and PAR.

Introduction

In addition to CFC's, two new sources of ozone destruction were recently identified whose combined effects with anthropogenic reactive chlorine have led to record low levels of stratospheric ozone: volcanic eruption particles (McCormick 1995), and methyl bromide, used for the treatment of agricultural soils (Cox 1991; Yagi et al. 1993; 1995). The rapid decline in stratospheric ozone concentrations has been confirmed by satellite measurements (Molina & Molina 1992). As a result, scientific concern has culminated about the ongoing global-scale change, and much research focuses on predicting the biological effects of the expected increase in UV-B radiation. A standard experimental approach in studying UV-B effects is the exposure of organisms to a predicted level of increase in UV-B dose. In order to simulate the increase in solar UV, elaborate systems have been constructed using UV-lamp banks, O₃ filters, Plexiglass and/or plastic foil cutoff filters, etc. (Santas, 1989; Tezuka et al. 1994; Tendel & Häder 1995). Such systems, including growth chambers, greenhouses, and field enclosures, can achieve

accurate replication of the desirable *mean* light intensity and spectral composition. However, the *fluctuations* of the above light parameters are very poorly, if at all simulated in most experimental setups. The data presented herein provide an assessment of the variation of daily and weekly dose of UV-A, UV-B and PAR, and the relative proportions of these three bands in the solar spectrum.

Methods and materials

Light measurements were performed in Ancient Korinthos, Greece (37°58' N, 23°0' E) in the period 17 June, 1995–17 November, 1995. The instrument used was a light dosimeter equipped with three sharp band sensors (Grubel, Ettlingen) for PAR (photosynthetically active radiation), UV-A and UV-B (Figure 1). The signals from the sensors are amplified, digitized by an analog/digital interface and stored in a dedicated computer. For this purpose, the 'Windose' program was developed specifically (Michael Lebert, Univ. of Erlangen). Each light sensor transmits 220 readings per

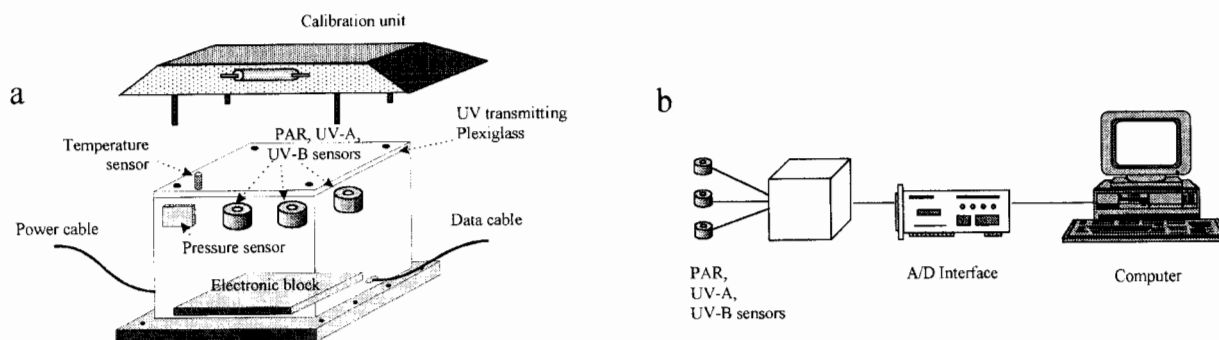

Figure 1. ELDONET light monitoring apparatus and data storage system: (a) Measurements are made with 3 sharp band sensors (PAR, UV-A, UV-B). The instrument can be operated on land or underwater (sensors here are shown inside the water tight chamber under a UV-transmitting Plexiglass top). A pressure sensor is used for indicating depth in the water column, while a temperature sensor is used for correcting erroneous readings due to overheating. (b) The analog signal from the sensors is digitized by an analog/digital (A/D) interface, and the data are fed in a dedicated computer. The data are displayed as a light intensity curve, and stored by 'Windose' software.

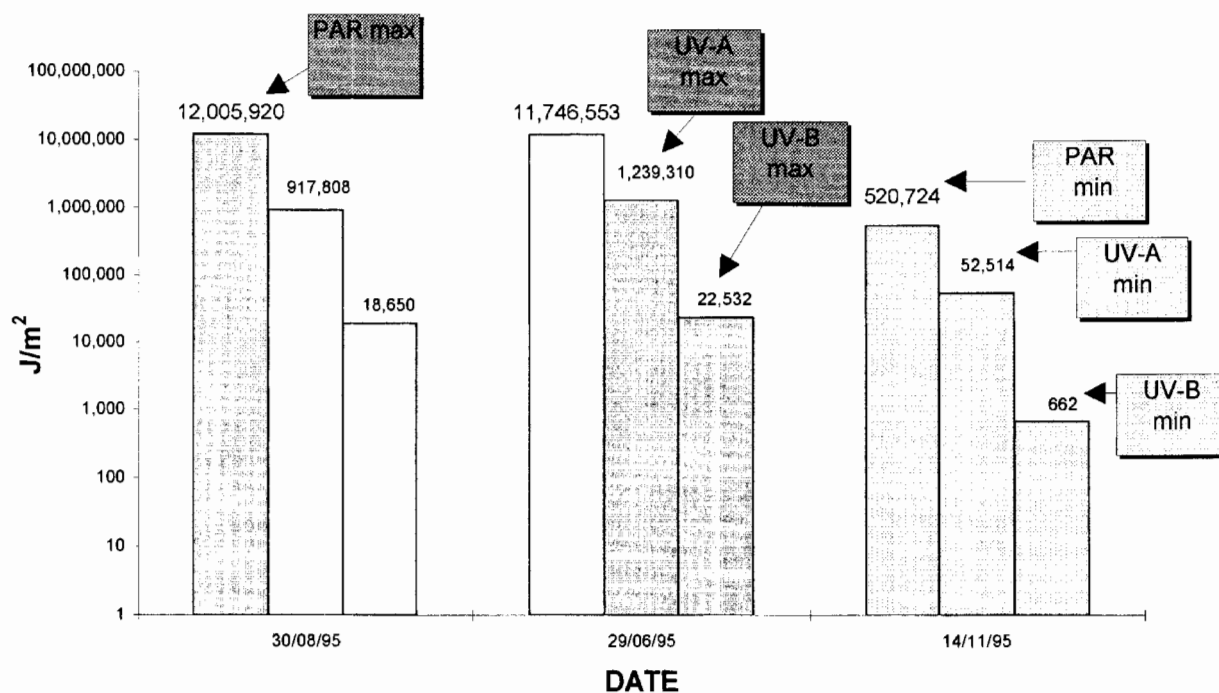

Figure 2. Daily dose maxima (dark columns) and minima (light gray columns) of solar PAR, UV-A and UV-B. The maximum daily PAR dose occurred on a different date (30 August, 1995) than the UV-A and UV-B daily maxima (29 June, 1995). All minima occurred on 14 November, 1995. The max/min ratios – a measure of daily dose variance during the course of this study – were 23 for PAR; 23.6 for UV-A; and 34 for UV-B.

minute which are then integrated and stored as minute doses. From the stored values larger duration doses (hourly, daily, weekly, etc.) can be easily calculated. The instrument was calibrated against a double monochromator spectroradiometer (Optronics OL 752). Specific care was taken to identify and correct for mechanical errors and deviation from the true values. For

practical purposes, during data collection the instrument is placed in a horizontal position. Upon running the monitoring program, the user enters information about geographic latitude, date, and time of the day. A program subroutine uses the user-defined data for calculating sunrise and sunset time and solar angle of incidence. Data monitoring begins automatically

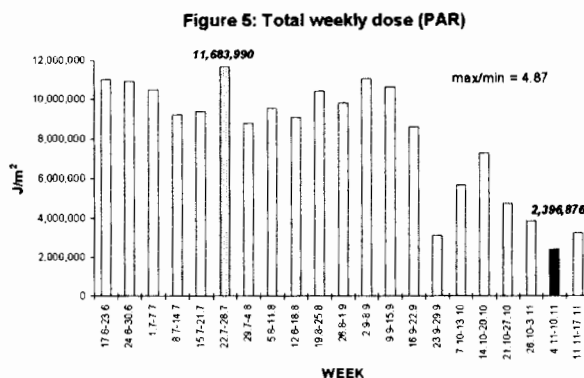
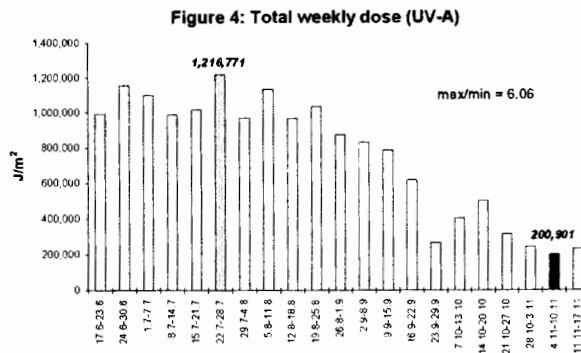
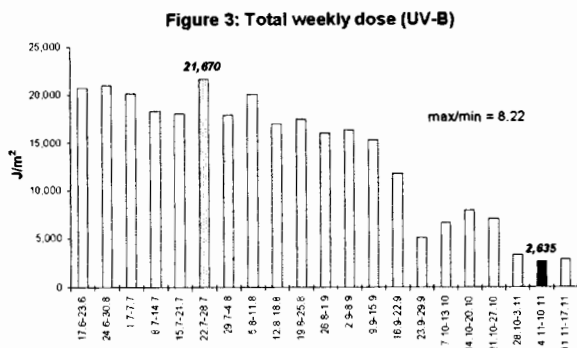

Figure 3–5. Total weekly dose fluctuations for UV-B (Figure 3), UV-A (Figure 4), and PAR (Figure 5). All maximum values (light gray columns) occurred during the period 22–28 July, 1995, while all minima (dark columns) occurred during 4–10 November, 1995. The max/min ratio increases with decreasing wavelength: 8.22 for UV-B; 6.06 for UV-A; and 4.87 for PAR.

one hour before sunrise, and ends one hour after sunset. The instrument’s internal temperature during the course of the experiment ranged between 18–45 °C. To correct for errors in light readings due to overheating, temperature is monitored simultaneously with light. The program then performs the necessary adjustments according to an initial temperature calibration curve.

Results and Discussion

The daily maximum PAR value occurred on a different date (30 August, 1995) than the maximum values for UV-A and UV-B (29 June, 1995). Minima for all three bands occurred on 14 November, 1995 (Figure 2). The daily UV-B minimum dose (662 J m⁻² on 14 November 1995) was 34 times lower than the maximum (22,532 J m⁻² on 29 June, 1995). For UV-A and PAR, the minima are 23 times lower than the corresponding maxima.

The total weekly dose varies less than the total daily dose, while the maximum/minimum ratio decreases

with increasing wavelength: 8.22 for UV-B, 6.06 for UV-A and 4.87 for PAR (Figures 3–5). Maximum and minimum doses for all three bands occurred on the fourth week of July and first week of November respectively (Figures 3–5). Spectral composition as measured by the relative proportion of the three bands at any time also varies considerably. In the 5th week of October the UV-B/PAR ratio was 2.42 times lower than in the 2nd week of August (Figure 6). In other words, during the summer months, there are more than twice as many UV-B photons per PAR unit dose than in the cold season. The UV-A/PAR and UV-B/UV-A ratios vary by a factor of 1.87 and 1.81 respectively (Figures 7, 8).

It is interesting to note that while the maximum of all other ratios occur in August, the UV-B/UV-A maximum occurred in late October (Figure 8). Unlike the UV-B/PAR and UV-A/PAR ratios, the UV-B/UV-A ratio did not decline during the two-month period of August–September.

These results point out the need for better simulation of light conditions in enhanced UV-B experiments

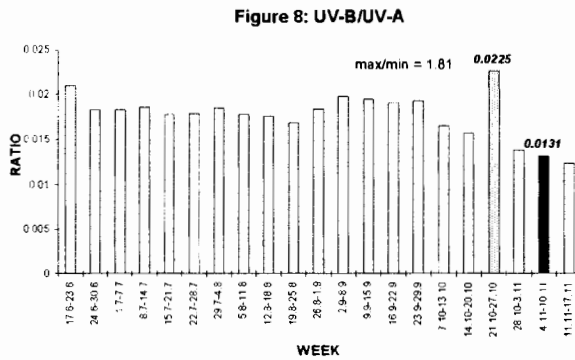
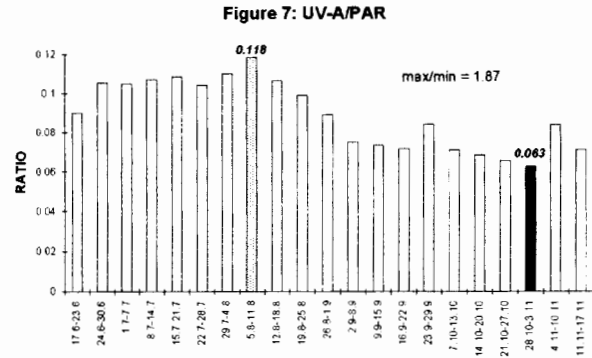
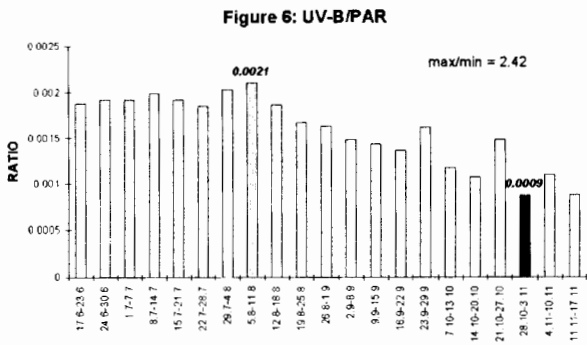

Figure 6–8. Spectral balance of solar UV-B, UV-A and PAR bands. Although total weekly dose was highest in the period 22–28 July 1995, (Figures 3–5), the relative proportion of UV/PAR photons was highest between 5–11 August 1995 (Figures 6 and 7; light gray columns). The minimum values were observed in the period 28 October–3 November, 1995 (Figures 6 and 7; dark columns). In other words, in the fall months, the weekly UV dose declines more rapidly than the weekly PAR dose. The UV-B/UV-A ratio (Figure 8) does not decline as much as the UV-B/PAR and UV-A/PAR ratios.

both in controlled environments and in the field. In most experimental setups, supplemental UV-B radiation is provided by steady output UV-B lamps. In the best of cases, the daily light cycle is simulated in a step-wise fashion, with irradiance periods centered midway through the photoperiod. Reports of ultraviolet irradiation experiments simulating light fluctuations due to sudden changes of atmospheric conditions are lacking from the literature, probably due to the practical limitations present in such attempts. Nevertheless, several researchers have pointed out the need to take account of spectral composition in photobiological studies (Caldwell et al. 1986; Smith & Baker 1989). In studying photobiological effects, it is important to keep in mind that the wavelength dependence of the biological photoprocess under consideration may vary with spectral balance. Bean plants, for instance, appear to be more resistant to enhanced levels of UV-B radiation when simultaneously exposed to high PAR conditions (Cen & Bornman 1990). Middleton and Teramura have pointed out the importance of UV-A control in UV-B

experiments conducted using artificial lamps and filters (Middleton & Teramura 1993a). The same authors conclude that potential complications in the interpretation of plant responses exist when UV-B experiments are conducted under low ambient light conditions (e.g. growth chambers; glasshouse in winter) or high daily UV-B irradiances (e.g. greater than or equal to 14 kJ m⁻²) for those plant responses that are sensitive to UV-A radiation (Middleton & Teramura 1993b). In some studies, shading of ambient radiation by lamp banks can be as high as 29% (Booker et al. 1992).

Light-dependent mechanisms such as photoreactivation, photorepair and photoprotection are driven by different wavelengths of the light spectrum including UV-A and PAR. In field studies, such mechanisms may alleviate or even reverse the impact of UV-B radiation on plant growth and development (Miller et al. 1994; Sinclair et al. 1990; Sullivan et al. 1992). It is also important to remember that the dose does not always cause an equal effect for a short exposure to a high intensity source as a long exposure to a low intensity

source even though the products are equal (Smith & Baker 1989). Therefore, in conducting long-term outdoor experiments, referring to the total dose may be of little value without examining the fluctuations of the biologically important light bands on a shorter time scale. Integrating or averaging, as practical as it may be, results in loss of valuable information.

Conclusions

For meaningful data interpretation in enhanced UV-B experiments, besides the monitoring of standard light parameters (intensity, spectral composition, total dose, biologically weighted dose), the natural radiation fluctuations – periodical and random – should also be accounted for. It is also necessary to examine the interaction of the different light bands (UV-A, UV-B and PAR), since photodamage and photorepair mechanisms occur simultaneously. Laboratory experiments should strive for closer simulation of the diurnal and seasonal changes in light intensity and spectral balance. In nature, darkness may not vary, but light does.

Acknowledgements

This study was supported by EC grant EV5V-CT94-0425, DG-XII (Environment Programme).

References

- Booker, F. L., Fiscus, E. L., Philbeck, R. B., Heagle, A. S., Miller, J. E. & Heck, W. W. 1992. A supplemental ultraviolet-B radiation system for open-top field chambers. *J. Environ. Qual.* 21: 56–61.
- Caldwell, M. M., Camp, L. B., Warner C. W., & Flint, S. D. 1986. Action spectra and their key role in assessing biological consequences of solar UV-B radiation change. pp. 87–111. In: *Stratospheric Ozone Reduction, Solar Ultraviolet Radiation and Plant Life*, Worrest R. C. and Caldwell M. M., (eds) Springer-Verlag, Berlin
- Cen, Y. P. & Bornman, J. F. 1990. The response of bean plants to UV-B radiation under different irradiances of background visible light. *J. Exp. Bot.* 41: 1489–1495.
- Cox, C. 1991. Methyl bromide is more bad news of stratospheric ozone. *J. Pestic. Reform. Publ.* 11: 30.
- McCormick, M. P. 1995. Atmospheric effects of the Mt Pinatubo eruption. *Nature* 373: 399–404.
- Middleton, E. M. & Teramura, A. H. 1993a. The role of flavonol glycosides and carotenoids in protecting soybean from ultraviolet-B damage. *Plant Physiol.* 103: 741–752.
- Middleton, E. M. & Teramura, A. H. 1993b. Potential errors in the use of cellulose diacetate and mylar filters in UV-B radiation studies. *Photochem. Photobiol.* 57: 744–751.
- Miller, J. E., Booker, F. L., Fiscus, E. L., Heagle, A. E., Pursley, W. A., Vozzo, S. F. & Heck, W. W. 1994. Ultraviolet-B radiation and ozone effects on growth, yield, and photosynthesis of soybean. *J. Environ. Qual.* 23: 83–91.
- Molina, M. J. & Molina, L. T. 1992. Stratospheric ozone. *A. C. S. Symp. Ser. Am. Chem. Soc. Washington, D.C.* 483: 24–35.
- Santas, R., 1989. Effects of Solar Ultraviolet Radiation on Tropical Algal Assemblages. Ph.D. Dissertation. The George Washington University, Washington, DC.
- Sinclair, T. R., N'Diaye, O. & Biggs, R. H. 1990. Growth and yield of field-grown soybean in response to enhanced exposure to ultraviolet-B radiation. *J. Environ. Qual.* 19: 478–481.
- Smith, R. C., & Baker, K. S., 1989. Stratospheric ozone, middle ultraviolet radiation and phytoplankton productivity. *Oceanogr.* 11/89, 4–10.
- Sullivan, J. H., Teramura, A. H. & Ziska, L. H. 1992. Variation in UV-B sensitivity in plants from a 3,000-m elevational gradient in Hawaii. *Am. J. Bot.* 79: 737–743.
- Tendel, J. & Häder, D. -P., 1995. Effects of UV radiation on orientation movements of higher plants. *J. Photoch. Photobiol. B:* 27: 67–72.
- Tezuka, T., Yamaguchi, F. & Ando, Y., 1994. Physiological activation in radish plants by UV-A radiation. *J. Photoch. Photobiol. B:* 24: 33–40.
- Yagi, K., Williams, J., Wang, N. Y. & Cicerone, -R. J. 1993. Agricultural soil fumigation as a source of atmospheric methyl bromide. *Proc. Natl. Acad. Sci. U.S.A* 1993. 90: 8420–8423.
- Yagi, K., Williams, J., Wang, N. Y. & Cicerone, R. J. 1995. Atmospheric methyl bromide (CH₃Br) from agricultural soil fumigations. *Science.* 267: 1979–1981.